



# Sectional Garage Doors

More convenience and security every day



*Hochwertige Qualität  
Engineered in Germany*

**HÖRMANN**





Hörmann brand quality	4
Advantages of sectional garage doors	6
Good reason to try Hörmann	8
Surface finish and design styles	12
L-ribbed	14
M-ribbed	18
Panelled	22
Door handles	26
Glazings	28
Wicket doors	30
Installation solutions	34
Garage door operators	38
Accessories	42
Performance characteristics	44
Dimensions and fitting data	46

Some of the doors shown are equipped with optional extras and do not always correspond to our standard models.

The surface finishes and colours shown are subject to the limitations of the printing process and cannot be regarded as binding.

All rights reserved. No part may be reproduced without our prior permission. Subject to changes.

# Hörmann brand quality

Reliable and future-oriented



**“A good reputation must be earned.”**

August Hörmann (1886-1944)

In line with the founder’s philosophy, the Hörmann brand today is a true promise of quality. The family-owned company has 90 years of experience in door and operator construction and is one of the leading manufactures in Europe, with sales of over 20 million doors. This makes a Hörmann sectional door a reassuring purchase.



## Brand quality from Germany

All doors and operator components developed and manufactured by Hörmann are well matched to each other as well as being tested and certified by independent, recognised institutes to ensure your safety. All doors are manufactured according to the DIN EN 9001 quality management system and meet the requirements of European standard 13241-1. Furthermore, our experienced employees work intensively on new products, continual further developments and improvements to details, which contributes to our patents and good products on the market.



## Garage doors for generations

Endurance tests under real conditions ensure mature series products with Hörmann quality. Thanks to good technical solutions and uncompromising quality assurance, you will receive a reliable warranty on all sectional doors and operators.



## Competent advice

Experienced specialists from our customer-orientated sales organisation accompany you from the planning stage, through technical clarification up to the final building inspection. Complete working documentation, such as technical manuals, is not only available in printed form, apart from that it is always accessible and up-to-date at [www.hoermann.com](http://www.hoermann.com).

## **Benefit from numerous advantages**

**Sectional doors always fit and save space**



Sectional doors open vertically upwards and are suspended under the ceiling to save space. This construction principle means you can make full use of the space inside and in front of the garage. Additionally, sectional garage doors can be fitted in every garage door opening, providing you with a wider passage in width and better sealing.

**Treat yourself to this comfort and convenience.**



## **Make better use of inside and outside space More freely enter and exit the garage**



### **For various fitting situation**

The shape of the garage door opening is not of prime importance. Whether square, angled, with segmental or full centred arch – a sectional door always fits.



Narrow passage width  
with old up-and-over doors



Complete passage width  
with modern sectional doors

### **Wider passage**

With older up-and-over doors, driving in and out is often a matter of millimetres. Sectional doors with a passage width extended by up to 14 cm also make it much easier to park modern, larger vehicles and SUVs.



### **Sealed all-round**

Flexible and weather-resistant seals on all four sides of Hörmann's sectional doors keep out the wind, rain and snow. Good-quality intermediate seals between the door sections of double-skinned doors provide for additional sealing. Thanks to its large-sized profile lip, the bottom seal can easily accommodate slight irregularities in the floor.

# Good reasons to try Hörmann

## Delicate appearance

Woodgrain



Micrograin



Decograin — Golden Oak

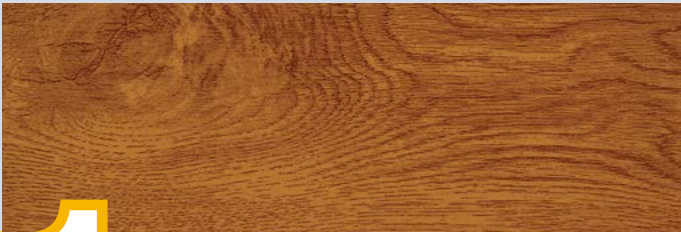

# 1

## Various surface finishes

### Elegant surface decors to choose

Hörmann provides various surface finishes to meet various kinds of requirements. Woodgrain and Micrograin surface finish are standard in RAL 9016, Grey RAL 9002, White aluminum RAL 9006 and Anthracite grey RAL 7016, optionally in around 200 colours from the RAL colour chart for Woodgrain. We also provide Decograin surface finishes in Golden Oak, Rosewood, Dark Oak and Night Oak.

# 2

## More security, of course

### Automatic door locking

Uninvited guests barely stand a chance with Hörmann automatic sectional doors. When the garage door is closed, the anti-lift kit automatically engages in the operator boom's stop, it then locks immediately and is secured against forced opening. This door latching functions pretty good, and in contrast to competitor operators, continues to secure the door even when the power fails.

# Good reasons to try Hörmann Innovations from the market leader

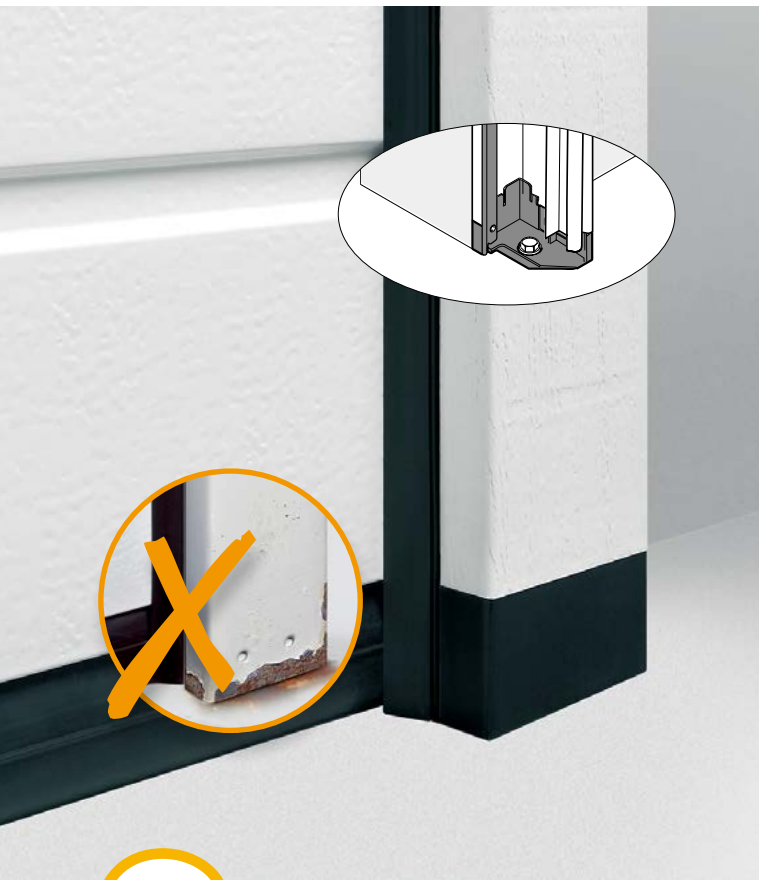

# 3

## Good long-term protection

### Also resistant to waterlogging

A non-brittle, 4 cm plastic frame shoe offers long-term protection against corrosion (even with waterlogging) that is unmatched by competitor solutions. The frame shoe completely covers the frame in the area susceptible to rust. Only this offers true long-term protection. Together with the door's bottom seal, the frame shoe makes for a bottom edge that is visually appealing.



# 4

## Efficient thermal insulation

### With thermal break between the frame and the building structure

*A well-insulated garage door is always recommended when the garage and the home are directly connected. To further improve the already good insulation values, Hörmann has developed the ThermoFrame frame connection, a plastic profile that can be simply fitted together with the door frame.*

This creates a thermal break between the frame and the brickwork, improving thermal insulation by up to 15 %\*. The optional ThermoFrame frame connection is available for all Hörmann sectional doors.

\* With a door surface of 5000 × 2125 mm



### Tested safety

Hörmann automatic sectional doors have been tested and certified by TÜV in accordance with the TTZ directive "Break-in resistance for garage doors".



# 5

## Fascia panels as standard

### Make up for insufficient headroom

For garage doors, the fascia panel is a good practical solution to make up for insufficient headroom. For all door versions, our standard fascia panels always match the door colour or style and can thus be visibly mounted in the opening. The standard single-skinned fascia panel which is 95 mm high can meet most situations.



# 6

## Side wall fitting, no problem

### Properly adjusted installation solution

The sectional door frame can be fitted to the side wall of the garage with Hörmann universal anchors. Irregularities in the wall can be easily compensated, leaving the reveal intact.

# Good reasons to try Hörmann

Hörmann BiSecur: The modern radio system for garage door and entrance gate operators



# 7

## Wicket doors with trip-free threshold

### Accessible passageway

A wicket door in the garage door lets you easily access gardening tools, bikes or wheelbarrows in your garage. The stainless steel threshold of the wicket door is only 10 mm high at the centre and 5 mm at the edges. This reduces the risk of tripping and makes it easier to wheel things through.

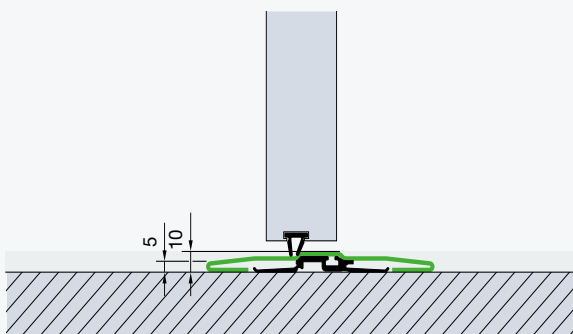

# 8

## Bi-directional radio system BiSecur

### The modern radio system for garage door and entrance gate operators

Our bi-directional, good-security BiSecur radio system is based on future-oriented technology that allows you to conveniently and safely operate garage doors, entrance gates, lights and much more.

With a stable, interference-free range, the newly developed, secure BiSecur encryption protocol makes sure that no-one can copy your radio signal. Tested and certified by security experts at the Bochum University and as safe as online banking.

### Convenient inquiry of the door position

You no longer have to go out in all kinds of weather to check if your garage door is closed. With a single push of a button, the LED colour on the hand transmitter HS 5 BS shows you whether the door is open or closed. If required, another push of a button closes the door.

# Double-skinned steel sectional door LPU 42

## Good thermal insulation and wide variety of surface finishes

### LPU

Double-skinned LPU 42 doors offer good insulation. Moreover, the 42-mm-thick sections give the door the greatest stability and make for quiet operation.

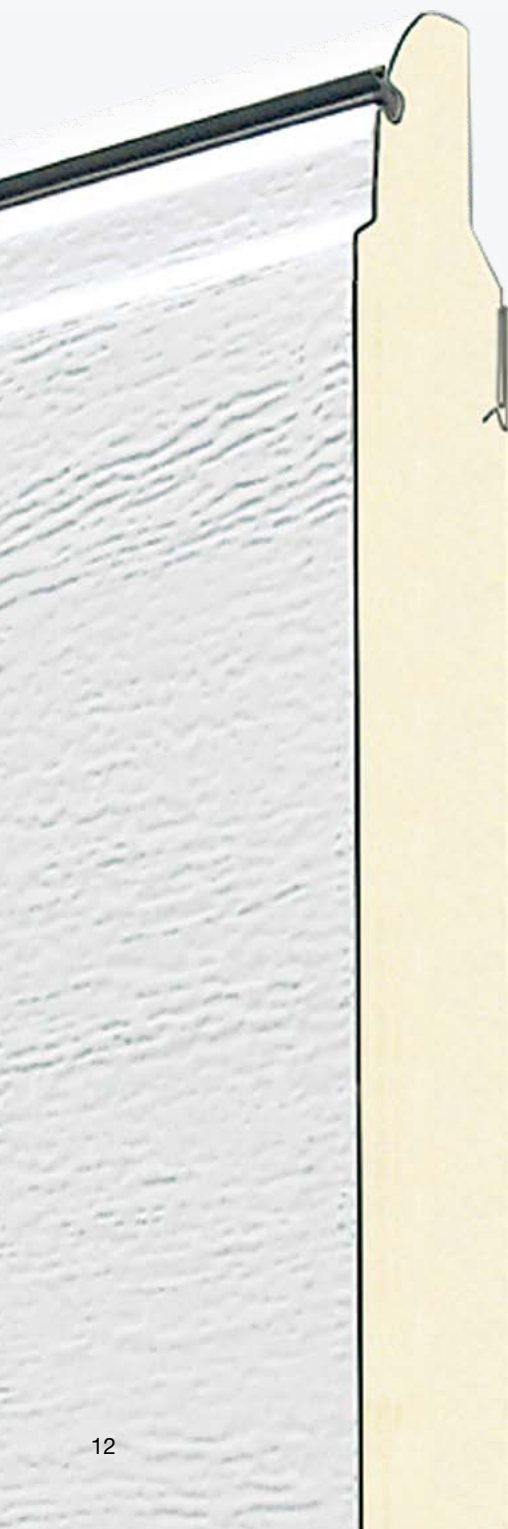

### Woodgrain

Traffic white RAL 9016

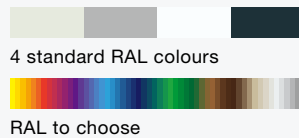

Woodgrain is standard in Grey RAL 9002, White aluminum RAL 9006, Traffic white RAL 9016 and Anthracite grey RAL 7016, optionally in around 200 colours from the RAL colour chart.

The surfaces are well protected against rust. Rain runs off without leaving any streaky marks thanks to the use of hot-galvanised material and a good-quality polyester-primer coating on both sides. A grey haze from air pollution is largely prevented.

On this inexpensive, robust surface with an authentic sawn timber look, minor scratches can be easily repaired by working with the texture.

**Ordering width 6000 mm**  
**Ordering height 3034 mm**  
 16 kinds of grid height  
 ( 8 preferred options )

### Micrograin

Traffic white RAL 9016

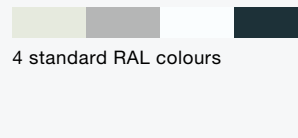

This surface features a wave profile that is embossed into smooth steel, producing attractive light and shadow effects. Micrograin is standard in Traffic white RAL 9016, Grey RAL 9002, White aluminum RAL 9006 and Anthracite grey RAL 7016.

**Ordering width 6000 mm**  
**Ordering height 3034 mm**  
 16 kinds of grid height  
 ( 8 preferred options )

### Decograin

Golden Oak

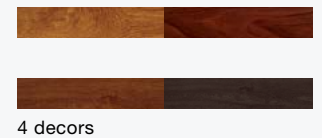

Decograin is available in four natural-looking timber designs. An embossed wood grain gives it all the aesthetics of timber. The door remains beautiful for a long time thanks to the surface protection of the UV-resistant plastic film coating on the outside of the steel sections.

This finely structured surface is an ideal choice for price-conscious owners and is suited for modern homes.

**Ordering width 6000 mm**  
**Ordering height 3000 mm**  
 8 kinds of grid height  
 ( 8 preferred options )

# Overview of steel sectional doors

## Styles and dimensions

### L-ribbed

L-ribbed design is only available on Micrograin surface.

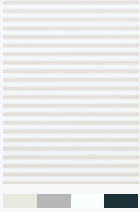

### M-ribbed

M-ribbed design is available on both Woodgrain and Decograin surface.



Golden Oak

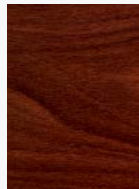

Rosewood



Dark Oak



Night Oak

### S-panelled

S-panelled design is available on Woodgrain and Decograin surface.  
S-panelled size 433 x 307 mm



Golden Oak



Rosewood



Dark Oak



Night Oak



L-ribbed in Micrograin, Traffic white, RAL 9016

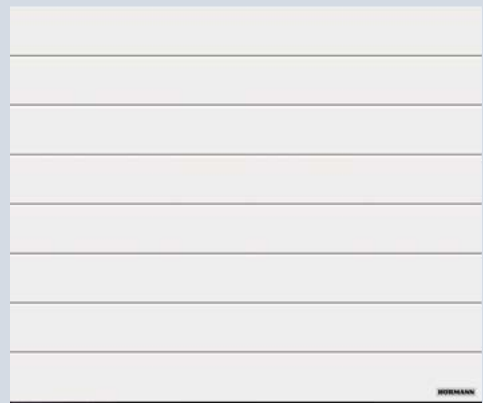

M-ribbed in Woodgrain, Traffic white, RAL 9016



S-panelled in Woodgrain, Traffic white, RAL 9016

# L-ribbed

The door style with elegance





L-ribbed with the surface finish Micrograin RAL 7016

# L-ribbed

Sturdy steel panels



L-ribbed with the surface finish Micrograin, RAL 9006

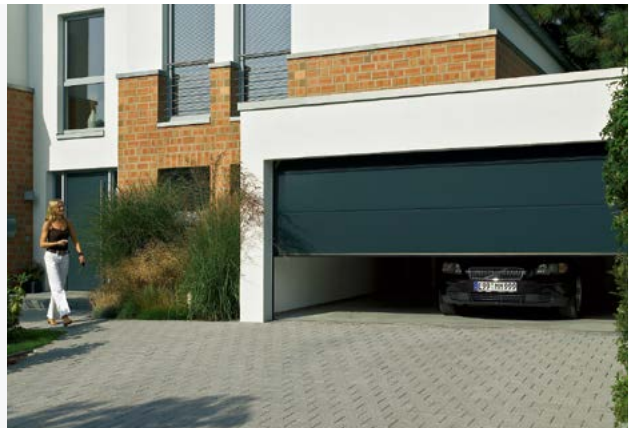

L-ribbed in surface finish Micrograin, RAL 7016

L-ribbed with the surface finish Micrograin, RAL 9002





L-ribbed with the surface finish Micrograin, RAL 9016

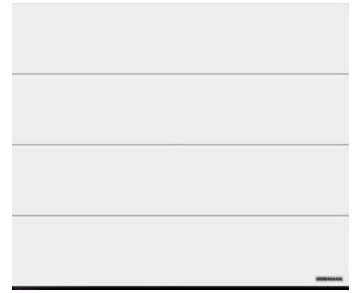

L-ribbed



**Micrograin**

Traffic white RAL 9016,  
Grey RAL 9002, White aluminum  
RAL 9006 and Anthracite grey  
RAL 7016 as standard.

# M-ribbed

The door style for modern architecture





M-ribbed with the surface finish Decograin Rosewood

# M-ribbed

More surface finishes to choose



M-ribbed with the surface finish Decograin Golden Oak



M-ribbed with surface finish Woodgrain in RAL 9016

M-ribbed with the surface finish Woodgrain in CH 703





M-ribbed with the surface finish Woodgrain in colour Anthracite grey, RAL 7016



M-ribbed



**Woodgrain**

Traffic white RAL 9016,  
Grey RAL 9002, White aluminum  
RAL 9006 and Anthracite grey RAL 7016  
as standard, other RAL colours are  
optionally available.

**Decograin**

Golden Oak  
Rosewood

# Panelled

The door style for classic buildings





S-panelled with the surface finish Woodgrain in the preferred colour Anthracite grey, RAL 7016

# Panelled

Available for full ordering sizes



S-panelled with the surface finish Woodgrain in Traffic white, RAL 9016



**S/U-panelled**

**Woodgrain**

Traffic white RAL 9016, Grey RAL 9002, White aluminum RAL 9006 and Anthracite grey RAL 7016 as standard, RAL to choose

**Decograin**

Golden Oak  
Rosewood



S-panelled

S-panelled with the surface finish Decograin Golden Oak



## Door Handles

It is your choice



### **More convenient solution for emergency situation**

For sectional garage doors without a second access door, we recommend the emergency release with door handle to deal with the emergency situation (e.g. in the event of a power failure). You can easily open the garage door manually from the outside by using the key and handle as well as the clutch pull wire connected to it internally.



Black plastic



Polished stainless steel



Brushed stainless steel



White cast aluminium, RAL 9016 steel



Silver cast aluminium



Brown cast aluminium, RAL 8028



Exterior handle with keys



Interior handle with Bowden cable

# Glazings





Clear synthetic glazing from Hörmann comes as standard with DURATEC glazing. It offers max. scratch resistance



### Aluminium frame

Available for both panelled and ribbed design. The anodised aluminium glazing frame (DIN 17611) in a natural finish E6 / C0 (previously E6 / EV 1) is available on request in door colour. You can choose the glazing with double synthetic panes in a clear version or crystal structure.



### Classic glazing

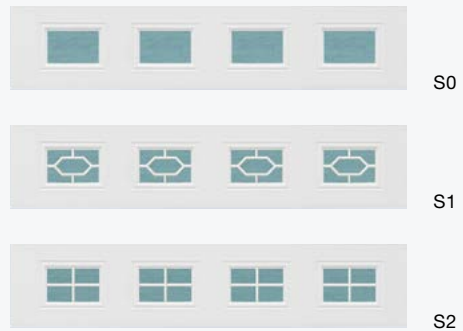

### Sunrise glazing



# Wicket door

An easy passage into your garage

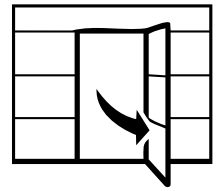

A door in the garage door lets you easily access whatever you have in your garage, such as gardening tools, bikes or wheelbarrows. The clear opening width of 940 mm offers a convenient passage, even for wide equipment or bicycles, motorbikes and scooters. Only Hörmann offers wicket doors with a stainless steel threshold that is merely 10 mm high in the centre and 5 mm high at the sides. This reduces the risk of tripping and makes it easier to wheel things through.

The top garage door section comes with a continuous lintel seal, also in the wicket door area.



Wicket door with 200mm height threshold





Wicket door with trip-free threshold



**1 Overhead door closers**  
As standard, wicket doors are supplied with slide rail door closers incl. integrated opening limiter and hold-open device (top Fig.).



**2 Stainless steel threshold**  
Reduces the risk of tripping and makes it easier to wheel things through. Height at centre only 10 mm and at edge only 5 mm.



**3 Robust door catch**  
This prevents the door leaf from dropping and warping.



**4 Concealed hinges**  
For a uniform door appearance, the wicket doors are equipped with concealed hinges as standard.

**Please note:**

- Wicket doors are only available for below size range:
- LPU 42 with track application N (up to 5 m door width)
  - LPU 42 with track application Z (up to 2.5 m door width)
  - LPU 42 with track application L (up to 5 m door width)
  - Clear opening width 940 mm

## Wicket door with trip-free threshold

Merely 10 mm high in the centre

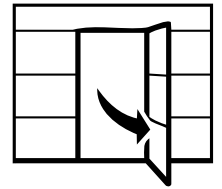

Two types of wicket doors are optionally available, one features a stainless steel threshold rail, while the other includes a part of bottom section. The stainless steel threshold rail of Hörmann wicket doors is particularly flat – which facilitates working and reduces accidents. This reduces the risk of tripping up and makes it considerably easier for slide carriages to pass through. Under certain circumstances, Hörmann wicket doors with trip-free threshold can even be used as escape doors and for barrier-free passages.



# Wicket door with bottom section threshold

With a threshold height 200 mm



Wicket door with bottom section threshold is another option for garage doors. The bottom section is equipped with EPDM floor seal to compensate for minor unevenness of the ground. This makes it suitable for more situations.

This design is particularly suitable for snowy regions. Even in situations where there is thick snow outside the door, the design of the outward-opening wicket door with a threshold ensures that it opens outward freely.

# Properly mounted and fitted

## Standard fitting and special anchors for side fixing



### Standard fitting

The sectional door can be fitted behind the opening [1]. The reveal guarantees stable fitting. This allows the frame to be screwed directly into the wall behind the opening.

Ideally, the available garage has at least 115 mm of clearance in the lintel area and a 90 mm sideroom.

**Hörmann sectional doors come with all the necessary fitting materials for this situation.**



### Optional special anchor for frame side fixing

The sectional door frame can be fitted to the side wall of the garage with Hörmann's universal anchors. Irregularities in the wall can be easily compensated, leaving the reveal intact.

[2] Fitting with up to 35 mm wall spacing

[3] Fitting with angled or irregular side wall

[4] Fitting with non-load bearing facades (facing brick or thermal insulation) with at least 90 mm sideroom



### Please note:

If the door is fitted in the opening by side fixing anchor, the ordering width and ordering height of the door should be reduced accordingly.



# Properly adjusted

## Frame covering and fascia panels

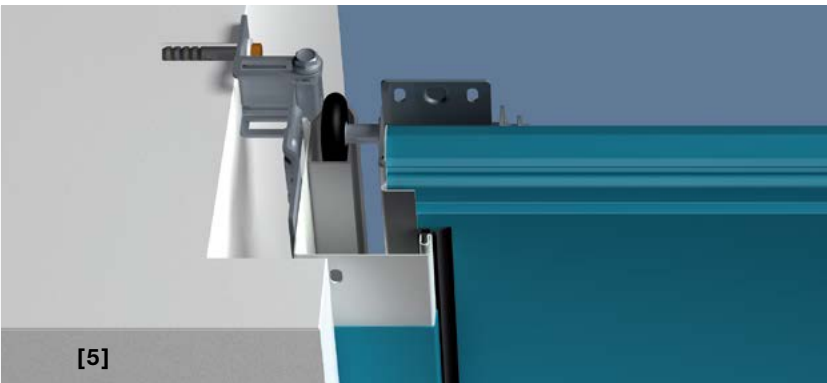

### Frame covering in the colour of the door

At Hörmann, side frames are delivered in smooth white as standard. With a frame covering that matches the door sections' colour or decor, you can also achieve a harmonious appearance for doors with different surface finishes.

[5] [6] 90-mm-wide frame covering for fitting behind the opening, with little sideroom



### Standard fascia panels

**For standard fitting behind the opening with small lintel space**

For all door versions, our standard fascia panels always match the door colour or style and can thus be visibly mounted in the opening.



### Double-skinned fascia panels

**For fitting in the opening with larger gap to the ceiling**

A matching, double-skinned additional fascia panel covers the gap between the ceiling and fascia panel. It is available for all surface finishes and colours or designs.

# Hörmann's good-quality garage door operators

Reliable, safe and maintenance-free



Hörmann operator technology  
Sophisticated and innovative technology that makes your life more convenient and safe.



**Garage door and entrance gate operators:  
Well matched from a single source**



Garage Door  
and Entrance Gate Operators  
Hohe Qualität und Zuverlässigkeit für Ihre Garage und Ihren Hof



More information can be found in the Garage door and entrance gate operators brochure.

# Four operator variants

Security both day and night with automatic locking



## SupraMatic P4

- Energy saving LED\* lights for the garage
- Low power consumption in standby below 1 watt
- 75 % faster opening speed compare to the ProMatic 3 operator
- Smart operation with the BlueSecur app
- Net worked with Smart Home systems via the standard HCP interface
- Standard with HSE 4 BS hand transmitter



## SupraMatic HT

- Smart operator
- More power, more function and faster speed
- Standard with black HS 5 BS hand transmitter
- For garage doors in size from 15.2 m<sup>2</sup>



## BiSecur

Standard 4-button hand transmitter HSE 4 BS, textured surface black with chrome caps

Garage door operators	ProMatic 4	SupraMatic P4	SupraMatic HT	HyperMatic 800/1000/1200
Bluetooth receiver	Optional (HET-BLE receiver)	Integrated, can be switched on and off	-	-
HCP bus connection	Integrated	Integrated	-	-
Cycles per day / hour	25 / 10	50 / 10	150 / 20	50 / 10
Pull and push force	600 N	750 N	1000 N	600 N/750 N/1000 N
Peak force	750 N	1000 N	1200 N	800 N/1000 N/1200 N
Max. opening speed	20 cm/s	25 cm/s**	22 cm/s	23 cm/s
Lighting	10 LED lights	30 LED chase lights	-	LED light
Max. door width	5000 mm	6000 mm	6000 mm	5000 mm/6000 mm/6000 mm
Max. door surface	11 m <sup>2</sup>	15.2 m <sup>2</sup>	18.25 m <sup>2</sup>	11 m <sup>2</sup> /15.2 m <sup>2</sup> /18.25 m <sup>2</sup>

\* 5 times brighter with the SupraMatic P in comparison to the ProMatic series 3

\*\* Up to 9 m<sup>2</sup> door leaf surface with SupraMatic P, up to max. 22 cm/s for larger door surfaces



### ProMatic 4

- Energy saving LED\* lights for the garage
- Low power consumption in standby below 1 watt
- 40 % faster opening speed compare to the ProMatic 3 operator
- Net worked with Smart Home systems via the standard HCP interface
- Standard with HSE 4 BS hand transmitter

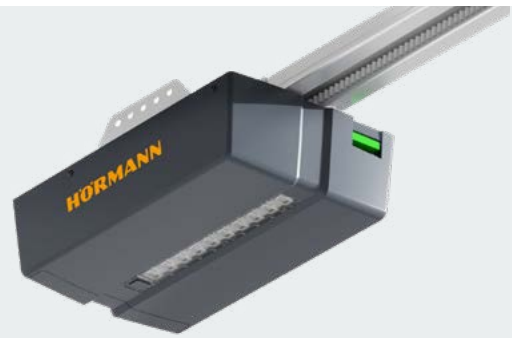

### HyperMatic 800 / 1000 / 1200

- Energy saving LED lights for the garage
- Max. opening speed is about 23 cm/s
- 2 x 7 - segment display
- Standard 4-button hand transmitter HSE 4 BS

## Hörmann BlueSecur

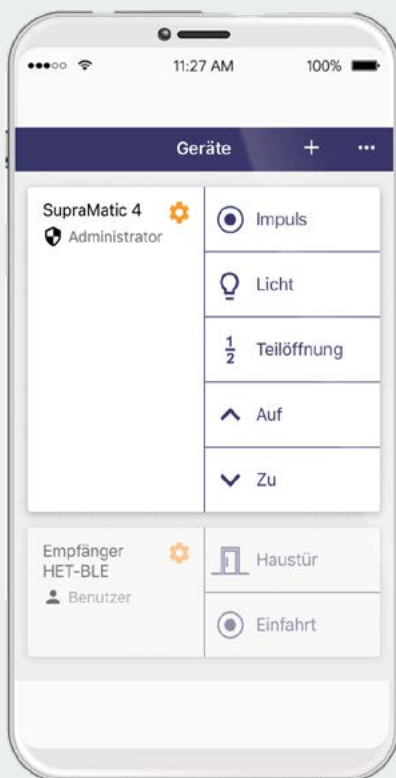

Standard Bluetooth receiver in SupraMatic 4 for smartphone operation using the Hörmann BlueSecur app



Photocell EL 101

### Increased security

Families with children particularly appreciate extra safety. A photocell installed in the garage opening immediately stops the door before it encounters an obstruction, which needs just a little bit extra expense but for a more extensive protection.



## Hand transmitter

### HS 5 BS

4 button functions

plus query button,

[1] High-gloss white

[2] Black textured surface **// NEW**



## Hand transmitter

### HS 4 BS

4 button functions,

[3] high-gloss black

## Hand transmitter

### HS 1 BS

1 button function,

[4] high-gloss black



## Hand transmitter

### HSE 4 BS

4 button functions,

[5] Black textured surface with plastic caps **// NEW**

## Hand transmitter

### HSS4 868 BS

4 button functions,

[6] high-gloss red



**Radio internal push button  
FIT 1 BS**

- Impulse, with status inquiry function
- For dry rooms only
- Temperature range: -20 °C to +60 °C
- Battery: 2 × 1.5 V LR03 / AAA
- Colour: Pure white RAL 9010
- Dimensions (W × H × D): 80 × 80 × 15 mm



**Radio internal push button  
FIT 5 BS**

- Impulse, with status inquiry function
- For dry rooms only
- Temperature range: -20 °C to +60 °C
- Battery: 2 × 1.5 V LR03 / AAA
- Colour: Pure white RAL 9010
- Dimensions (W × H × D): 80 × 80 × 15 mm



**Key switch**

**1 STUP 50**

**2 STAP 50**

In a recessed version and surface-mounted version, including 3 keys, zinc die-cast housing in White aluminium RAL 9006 with stainless steel panel



**Code switch CTR 1b/3b**

**CTR 1b:** 1 relay output for control of one door operator

**CTR 3b:** 3 separate relay outputs for the control of 2 operators and/ or choosing the direction, second opening height, yard illumination, Stop

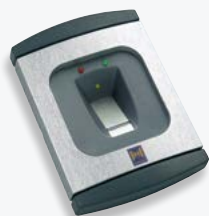

**Fingerscan FL 12/FL 100**

**FL 12:**

- Up to 12 fingerprints can be taught in
- Setting / programming via DIL switches on the interior device
- Impulse duration: 0.5 s or 5 s

**FL 100:**

- Up to 100 fingerprints can be taught in
- Setting / programming via 3 buttons and two 7-segment displays on the interior device
- Impulse duration: programmable from 0.5 s – 90 s



**UAP 1 Multi functional  
expansion junction box**

Applied for ProMatic & SupraMatic operators, with integrated pulse selection, partial activation, limit switch status feedback functions equipped with a 2-meter system cable.

Dimension: 110 × 70 × 55 mm (W × H × D);  
Protection category: IP 65

## Technically mature

Operating comfort with good security



Safety while operating the garage door is important for Hörmann. Hörmann sets the standards for this with its innovative solutions. This has been proved again and again through numerous Hörmann patents.

**And this provides you and your family with safety during daily use.**



## Safety features in accordance with European standard 13241-1

### Anti-fall safeguard / trap protection

Hörmann sectional doors are tested and certified in accordance with the good safety requirements of European standard 13241-1, not only on their own but also in combination with operators. It would be hard to find a safer sectional door.

**Hörmann garage door is your  
ideal choice!**



Hörmann patent

### Tension spring assembly with spring-in-spring system

Hörmann sectional doors with double tension springs and double cables per side safeguard the door leaf against crashing to the floor. Thanks to the patented spring-in-spring system, broken springs are prevented from flying out and causing injuries.

Sectional doors up to 3000 mm wide and 2625 mm high include the proven tension spring technology as standard.



Hörmann patent

### Torsion spring technology with integrated spring safety device

Hörmann sectional doors incorporate torsion springs on both sides featuring a patented spring safety device. In the event of a spring breaking, they arrest the door immediately, thereby preventing the door leaf from crashing to the floor. Larger sectional doors feature torsion spring technology.



Hörmann patent

### Secure guidance of the door in safety tracks

Adjustable, patented track rollers, sturdy roller holders and safety tracks ensure that there is no danger of the door "derailing". The door sections are safely parked under the ceiling.



### Finger trap protection on the inside, outside and on the hinges

The unique form of the door sections eliminates trap points, both between the sections and on the hinges. This reliable finger trap protection is offered by Hörmann.



### Trap guard on the side frame

With Hörmann, the frames are completely closed from top to bottom. There are no gaps between the door leaf and frame in which fingers could get trapped!

# Good thermal insulation

Tested and certified

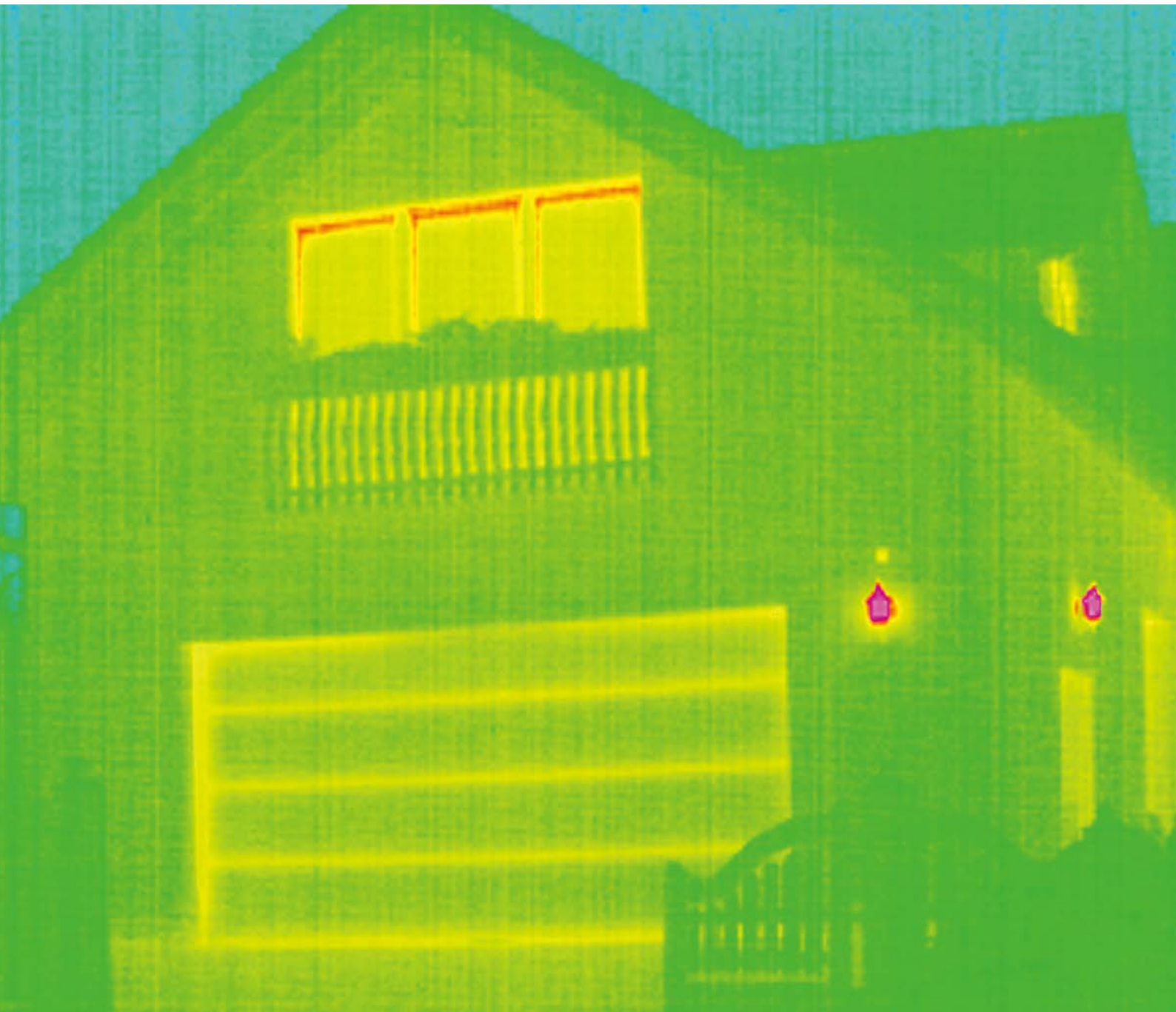

A well insulated garage door is always recommended when the garage and the home are directly connected. The ThermoFrame frame connection further improves the already good insulation values of the double-skinned Hörmann sectional garage doors.

**This reduces your energy costs.**



## ThermoFrame Improved thermal insulation for sectional doors

The plastic profile that can be simply fitted together with the door frame, creates a thermal break between the frame and the brickwork, improving the thermal insulation by up to 15 %\*.

In addition, extra lip seals on both sides and in the upper section of the door provide better sealing while lowering the loss of heating energy from the garage interior.

The ThermoFrame frame connection is optionally available for all Hörmann sectional garage doors.

## Performance characteristics according to European standard 13241-1

At Hörmann, the four important characteristics of thermal insulation, acoustic insulation, tightness and sealing, and wind load for garage doors are tested and certified.

### Thermal insulation

Section	U = 0.5 W/(m <sup>2</sup> ·K)
Door leaf	U = 0.9 W/(m <sup>2</sup> ·K)
Fitted door <sup>1)</sup>	U = 1.4 W/(m <sup>2</sup> ·K)

### Acoustic insulation

R = approx. 25 dB

Air	M-ribbed	Class 2
	L-ribbed and Panelled	Class 3

**Water** Class 3 <sup>2)</sup>

**Wind load** Class 3

\* For door size 5000 × 2125 mm

<sup>1)</sup> The U-values apply to fitted doors without glazing in the size: 5000 × 2125 mm

<sup>2)</sup> Up to 70 Pa water pressure



# Dimensions and fitting data

## Track applications and fitting dimensions

### Horizontal view

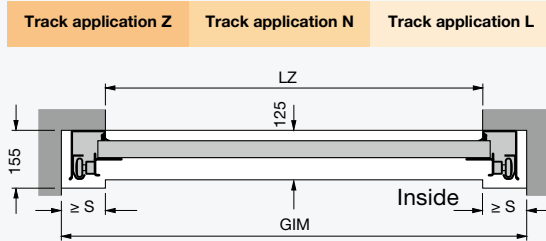

For ordering size in white area,  $S \geq 90$  and  $GIM \geq LZ + 180$ ;  
 For ordering size in blue area,  $S \geq 125$  and  $GIM \geq LZ + 250$ ;

### Fitting with track applications Z, N, L

Overall length operators	Track application Z	Track application N	Track application L
FS-K (3200 mm)	1820-2125	1820-2250	1820-2125
FS-M (3450 mm)	2126-2375	2251-2503	2126-2375
FS-L (4125 mm)	2376-2579	2504-3034	2376-3034

### Vertical views

#### Track application Z

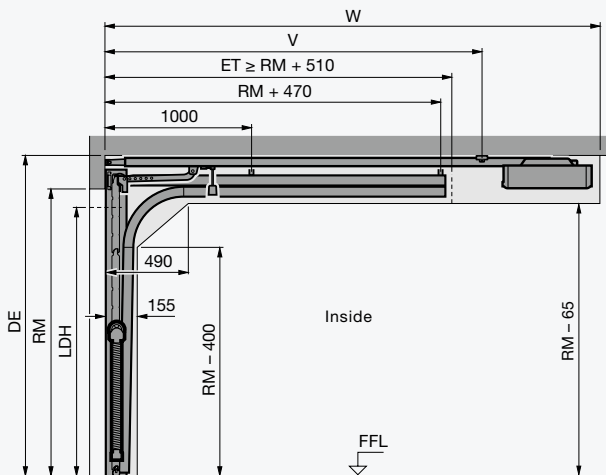

#### Track application N

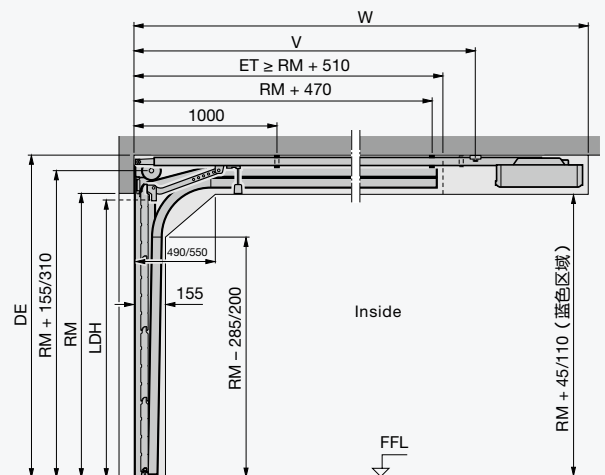

#### Track application L

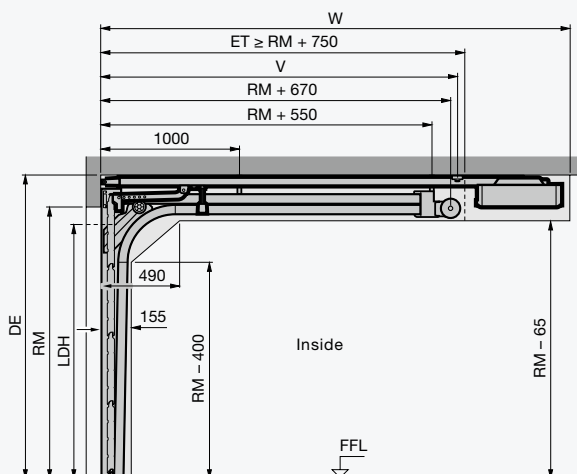

Dimensions in mm

# Hörmann: Quality without Compromise



Hörmann KG Amshausen, Germany



Hörmann KG Antriebstechnik, Germany



Hörmann KG Brandis, Germany



Hörmann KG Brockhagen, Germany



Hörmann KG Dissen, Germany



Hörmann KG Eckelhausen, Germany



Hörmann KG Freisen, Germany



Hörmann KG Ichttershausen, Germany



Hörmann Alkmaar B.V., Netherlands



Hörmann Legnica Sp. z o.o., Poland



Hörmann LLC, Montgomery IL, USA



Hörmann Flexon LLC, Burgettstown PA, USA



Hörmann Beijing, China



Hörmann Tianjin, China



Hörmann Changshu, China



Shakti Hörmann Ltd. India

Hörmann is a professional manufacturer worldwide that offers you a complete range of major building products from one source. We manufacture in specialized factories using the advanced production technologies. The comprehensive manufacturing, sales and service network in Europe, Asia and America makes Hörmann your strong international partner for the high-quality construction. "Quality without Compromise".

**GARAGE DOORS**  
**OPERATORS**  
**DOORS**  
**PARTITION WALLS**  
**INDUSTRIAL DOORS**  
**LOADING TECHNOLOGY**

All information and images are protected by copyright. No part of this brochure may be reproduced without our permission. Subject to changes.

Print: 06. 2026 / Issue: 06. 2026) 1121120091  
Some of the doors shown in this brochure have special features and therefore do not always represent the standard version.

[www.hoermann.com](http://www.hoermann.com)

**HÖRMANN**